



BOSCH

Quick Start Guide

RT 800



6721836164 (2022/03)



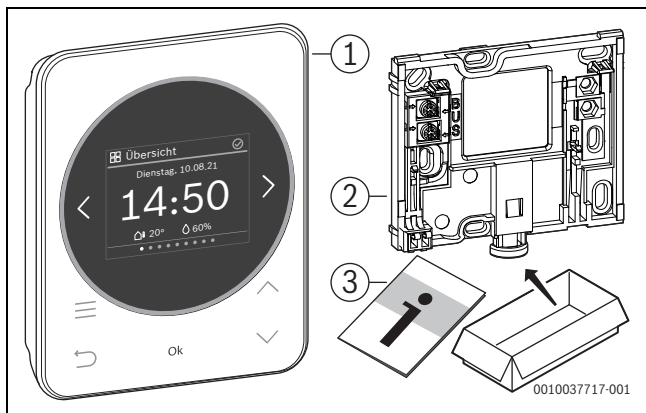

1

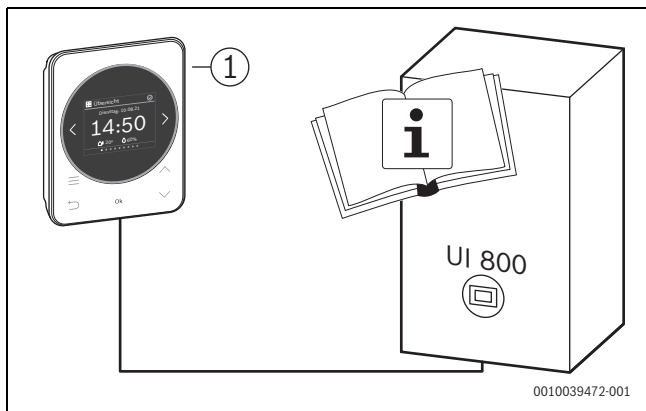

2



www.docs.bosch-thermotechnology.com/7738112961

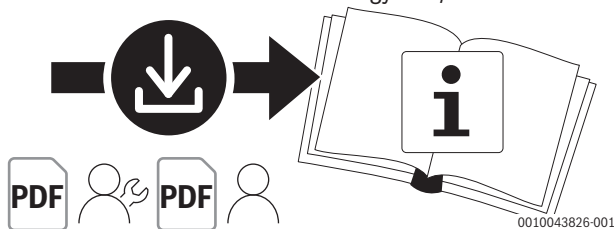

0010043826-001

3

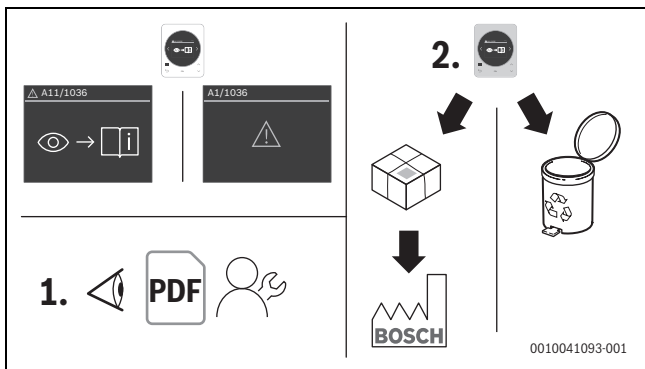

0010041093-001

4

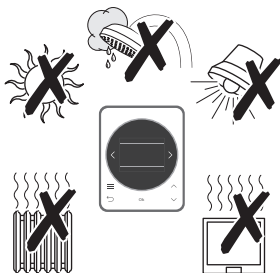
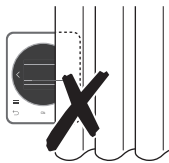
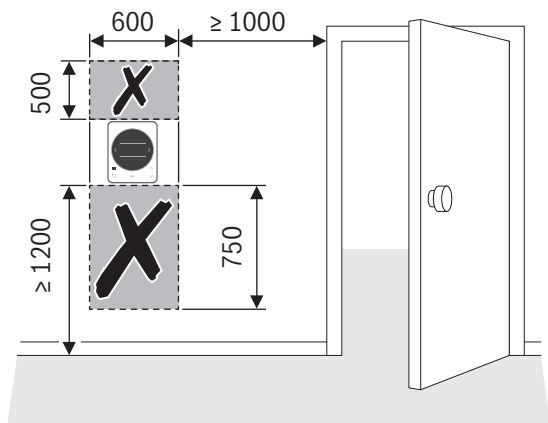



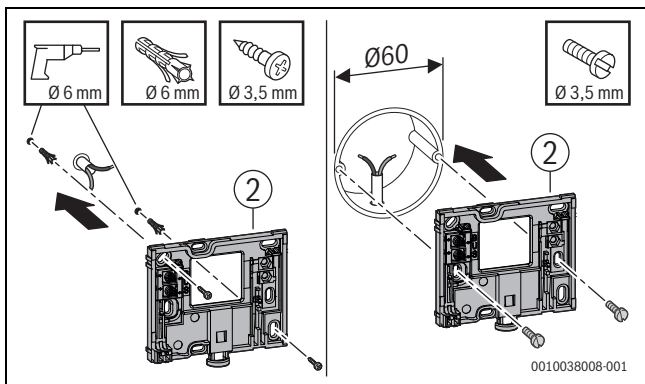

0010038006-001

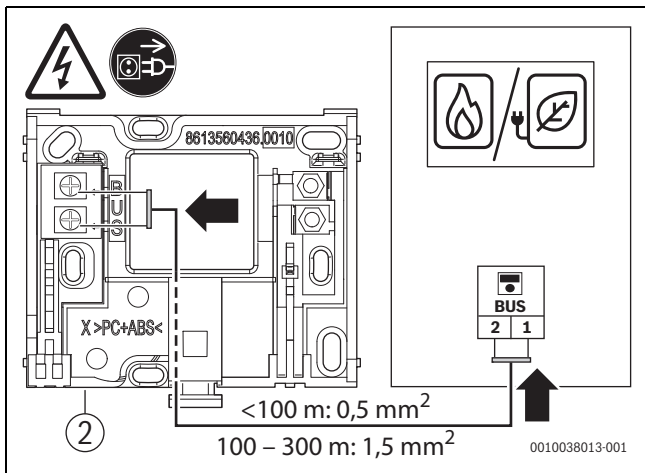

6



7

	RT 800
P_{\max}	0,6 W
IP-class	20
Pollution degree (EN 60664)	2
$T_{\text{press}} \downarrow \bullet$ (EN 60695-10-2)	90 °C
T_{amb}	0 – 50 °C
ErP (EU 811/2013; (EU) 2017/1369)	 Class V / 3 %,  Class II / 2 %,  Class VI / 4 %
Wi-Fi	-
BUS	EMS 2
m 	200 g
	$h = 95 \text{ mm}, w = 116 \text{ mm}, d = 21 \text{ mm}$

1

1 [cs] Všeobecné bezpečnostní pokyny

Pokyny pro cílovou skupinu

Tento návod je určen jak odborníkům pracujícím v oblasti plynových a vodovodních instalací, techniky vytápění a elektrotechniky, tak i provozovateli otopné soustavy.

- ▶ Dodržujte pokyny uvedené ve všech návodech komponent systému.
- ▶ Řiďte se bezpečnostními a výstražnými pokyny.
- ▶ Dodržujte národní a místní předpisy, technická pravidla a směrnice.

Jejich nerespektování může vést k materiálním škodám, poškození zdraví osob nebo dokonce k ohrožení jejich života.

Užívání k určenému účelu

- ▶ Výrobek používejte výhradně k řízení otopných soustav.

Každé jiné použití se považuje za použití v rozporu s původním určením. Škody, které by tak vznikly, jsou vyloučeny z odpovědnosti.

Nebezpečí opaření v místech odběru teplé vody

- ▶ Má-li být nastavována teplota TV vyšší než 60 °C, nebo bude-li zapínána termická dezinfekce, je nutné, aby bylo nainstalované směšovací zařízení. Při pochybnostech se poraďte s odborníkem.

1 [da] Generelle sikkerhedshenvisninger

Anvisninger for målgruppen

Denne vejledning henvender sig både til fagfolk inden for vandinstallationer og varme- og elektroteknik samt til brugeren af varmeanlægget.

- ▶ Overhold anvisningerne i alle vejledninger til anlægskomponenterne.
- ▶ Overhold sikkerheds- og advarselshenvisningerne.
- ▶ Overhold nationale og regionale forskrifter, tekniske regler og direktiver.

Hvis anvisningerne ikke overholdes, kan det forårsage materielle skader og/eller personskader, som kan være livsfarlige.

Forskriftsmæssig anvendelse

- ▶ Brug udelukkende produktet til regulering af varmeanlæg.

Al anden anvendelse er ikke forskriftsmæssig. Skader, som opstår som følge af forkert anvendelse, omfattes ikke af garantien.

Fare for skoldning på tapstederne for varmt vand

- ▶ Hvis varmtvandstemperaturen indstilles over 60 °C, eller den termiske desinfektion er tilkoblet, skal der installeres en blandingsanordning. Spørg fagfolk, hvis du er i tvivl.

1 [en] General safety instructions

Notices for the target group

These instructions are intended for experts who are skilled in dealing with water installations, heating and electrical systems as well as the operator of the heating system.

- ▶ Comply with all instructions of the system components.
- ▶ Observe the safety instructions and warnings.
- ▶ Follow national and regional regulations, technical regulations and guidelines.

Failure to comply with instructions may result in material damage and personal injury, including danger to life.

Intended use

- ▶ Use the product only to control heating systems.

All other use is considered unsuitable. Any damage resulting from prohibited operations is excluded from liability.

Risk of scalding at the DHW draw-off points

- ▶ If DHW temperatures above 60 °C are set or if thermal disinfection is activated, a mixer must be installed. If in doubt, ask your installer.

1 [fr] Consignes générales de sécurité

Consignes pour le groupe cible

Cette notice s'adresse aussi bien aux spécialistes en matière d'installation d'eau, en technique de chauffage et d'électricité, qu'aux utilisateurs des installations de chauffage.

- ▶ Respecter les consignes de toutes les notices des composants de l'installation.
- ▶ Respecter les consignes de sécurité et d'avertissement.
- ▶ Respecter les règlements nationaux et locaux, ainsi que les règles techniques et les directives.

Le non-respect peut entraîner des dommages matériels, des dommages corporels, voire la mort.

Utilisation conforme à l'usage prévu

- ▶ Utiliser ce produit exclusivement pour réguler les installations de chauffage.

Toute autre utilisation n'est pas conforme. Les dégâts éventuels qui en résulteraient sont exclus de la garantie.

Risques de brûlure aux points de puisage de l'eau chaude sanitaire

- ▶ Pour régler des températures ECS supérieures à 60 °C ou enclencher la désinfection thermique, un mitigeur thermostatique doit être installé. En cas de doute, consulter un spécialiste.

1 [nl] Algemene veiligheidsaanwijzingen

Instructies voor de doelgroep

Deze instructie is bedoeld voor de vakman op het gebied van de waterinstallaties, verwarmings- en elektrotechniek en voor de gebruiker van de cv-installatie.

- ▶ Houd de aanwijzingen in alle instructies van de installatiecomponenten aan.
- ▶ Houd de veiligheids- en waarschuwinginstructies aan.
- ▶ Houd de nationale en regionale voorschriften, technische regels en richtlijnen aan.

Indien deze niet worden aangehouden kan materiële schade en lichamelijk letsel en zelfs levensgevaar ontstaan.

Correct gebruik

- ▶ Gebruik het product uitsluitend voor de regeling van cv-installaties.

Ieder ander gebruik komt niet overeen met de voorschriften. Daaruit resulterende schade valt niet onder de aansprakelijkheid.

Verbrandingsgevaar aan de tappunten van het warm water

- ▶ Wanneer warmtapwatertemperaturen boven 60 °C zijn ingesteld of de thermische desinfectie is ingeschakeld, moet een thermostatische mengkraan worden geïnstalleerd. Vraag bij twijfel de installateur.

1 [nl-BE] Algemene veiligheidsvoorschriften

Instructies voor de doelgroep

Deze handleiding is bedoeld voor de vakman op het gebied van de waterinstallaties, verwarmings- en elektrotechniek en voor de gebruiker van de cv-installatie.

- ▶ Houd de instructies in alle handleidingen van de installatiecomponenten aan.
- ▶ Neem de veiligheidsinstructies en waarschuwingsaanwijzingen in acht.
- ▶ Neem de nationale en regionale voorschriften, technische regels en richtlijnen in acht.

Indien deze niet worden aangehouden kunnen materiële schade, lichamelijk letsel en zelfs levensgevaar ontstaan.

Gebruik volgens de voorschriften

- ▶ Gebruik het product uitsluitend voor het regelen van cv-installaties.

Ieder ander gebruik komt niet overeen met de voorschriften. Daaruit resulterende schade valt niet onder de aansprakelijkheid.

Verbrandingsgevaar aan de tappunten van het warm water

- ▶ Installeer een thermostatische mengkraan wanneer warmwatertemperaturen boven 60 °C zijn ingesteld of de thermische desinfectie is ingeschakeld. Vraag bij twijfel de vakman.

1 [pl] Ogólne wskazówki bezpieczeństwa

Wskazówki dla grupy docelowej

Niniejsza instrukcja jest adresowana zarówno do monterów instalacji wodnych, grzewczych i elektrotechnicznych, jak i użytkownika instalacji grzewczej.

- ▶ Stosować się do wszelkich poleceń zawartych w instrukcjach komponentów instalacji.
- ▶ Postępować zgodnie ze wskazówkami dotyczącymi bezpieczeństwa oraz ostrzegawczymi.
- ▶ Należy przestrzegać krajowych i miejscowych przepisów oraz zasad i dyrektyw technicznych.

Ignorowanie tych wskazówek grozi uszkodzeniami materialnymi i urazami cielesnymi ze śmiercią włącznie.

Zastosowanie zgodne z przeznaczeniem

- ▶ Produkt jest przeznaczony wyłącznie do regulacji instalacji grzewczych.

Jakiegokolwiek inne użytkowanie jest uważane za niezgodne z przeznaczeniem. Szkody powstałe w wyniku takiego użytkowania są wyłączone z odpowiedzialności producenta.

Niebezpieczeństwo oparzenia w punktach poboru ciepłej wody

- ▶ Jeśli temperatura ciepłej wody zostanie ustawiona powyżej 60 °C lub włączono dezynfekcję termiczną, należy zainstalować mieszacz. W razie wątpliwości zwrócić się do instalatora.

1 [sk] Všeobecné bezpečnostné pokyny

Pokyny pre cieľovú skupinu

Tento návod je určený pre odborných pracovníkov pracujúcich v oblasti inštalácií vodovodných, vykurovacích a elektrotechnických zariadení ako aj pre prevádzkovateľa vykurovacieho systému.

- ▶ Dodržujte pokyny uvedené vo všetkých návodoch komponentov zariadenia.
- ▶ Dodržujte bezpečnostné a výstražné upozornenia.
- ▶ Dodržujte národné a regionálne predpisy, technické pravidlá a smernice.

V prípade nedodržania pokynov môže dôjsť k vecným škodám a zraneniam osôb, až s následkom smrti.

Správne použitie

- ▶ Výrobok používajte výlučne na reguláciu vykurovacích zariadení.

Akékoľvek iné použitie nie je správne. Na škody v dôsledku porušenia týchto ustanovení sa nevzťahuje záruka.

Nebezpečenstvo obarenia na miestach odberu teplej vody

- ▶ V prípade nastavenia teplôt teplej vody vyšších ako 60 °C alebo ak je zapnutá tepelná dezinfekcia, je nutné nainštalovať zmiešavacie zariadenie. V prípade pochybností sa spýtajte odborníka.

1 [sv] Allmänna säkerhetsanvisningar

Anvisningar för målgruppen

Anvisningen är både avsedd för installatörer för vatteninstallationer, husvärme och elteknik samt för värmesystemets användare.

- ▶ Följ instruktionerna i alla anvisningar för anläggningskomponenterna.
- ▶ Följ säkerhets- och varningsanvisningar.
- ▶ Beakta nationella och lokala föreskrifter, tekniska regler och regleringar.

Om anvisningarna inte följs kan det leda till saksador och personskador och i värsta fall livsfara.

Användningsområde

- ▶ Produkten ska endast användas för reglering av värmesystem.

All annan användning är inte ändamålsenlig. Vi ansvarar inte för skador som beror på otillåten användning.

Risk för skällning vid avtappningsställena för varmvatten

- ▶ Om varmvattentemperaturer över 60 °C är inställda eller om termisk desinfektion är aktiverad måste en termostatisk blandningsventil installeras. Om du är osäker, fråga din installatör.

- cs** Následující text je z právních důvodů v angličtině.
- da** Følgende tekst er på engelsk af juridiske årsager.
- en** The following text is in English for legal reasons.
- fr** Le texte suivant est en anglais pour des raisons juridiques.
- nl** De navolgende tekst is om juridische redenen in het Engels.
- nl-BE** De navolgende tekst is om juridische redenen in het Engels.
- pl** Poniższy tekst z przyczyn prawnych sporządzony jest w języku angielskim.
- sk** Nasledovný text je z právnych dôvodov uvedený v angličtine.
- sv** Följande text är av juridiska skäl på engelska.

Open Source Licensing

2 List of used Open Source Components

This document contains a list of open source software (OSS) components used within the product under the terms of the respective licenses. The source code corresponding to the open source components is also provided along with the product wherever mandated by the respective OSS license.

Name of OSS Component	Name and Version of License (License text → Chapter 3)	More Information
STM32cube generated HAL files	BSD (Three Clause License)	COPYRIGHT© 2017 STMicroelectronics COPYRIGHT© 2016 STMicroelectronics COPYRIGHT© 2015 STMicroelectronics COPYRIGHT© 2014 STMicroelectronics COPYRIGHT© 2013 STMicroelectronics

Name of OSS Component	Name and Version of License (License text → Chapter 3)	More Information
mbed TLS (formerly PolarSSL)	Apache License 2.0	Copyright (C) 2006-2015, ARM Limited, All Rights Reserved Copyright (C) 2006-2016, Arm Limited (or its affiliates), All Rights Reserved Copyright (C) 2016 ARM Limited, All Rights Reserved Copyright © 2006-2017, ARM Limited, All Rights Reserved Copyright © 2015-2016, ARM Limited, All Rights Reserved Copyright © 2009-2016, ARM Limited, All Rights Reserved Copyright © 2014-2016, ARM Limited, All Rights Reserved Copyright (C) 2013-2017, ARM Limited, All Rights Reserved Copyright © 2014-2017, ARM Limited, All Rights Reserved Copyright (C) 2017, Arm Limited (or its affiliates), All Rights Reserved Copyright © 2012-2016, ARM Limited, All Rights Reserved Copyright © 2006-2018, ARM Limited, All Rights Reserved Copyright © 2015-2018, ARM Limited, All Rights Reserved



Provided that within certain OSS-Licenses (e.g. LGPL-2.0) necessary, reverse-engineering is allowed for the respective software component to the required extent. This shall not apply for other components of the software.

3 License Texts

3.1 BSD (Three Clause License)

Redistribution and use in source and binary forms, with or without modification, are permitted provided that the following conditions are met:

- Redistributions of source code must retain the above copyright notice, this list of conditions and the following disclaimer.
- Redistributions in binary form must reproduce the above copyright notice, this list of conditions and the following disclaimer in the documentation and/or other materials provided with the distribution.
- Neither the name of the copyright holder nor the names of its contributors may be used to endorse or promote products derived from this software without specific prior written permission.

THIS SOFTWARE IS PROVIDED BY THE COPYRIGHT HOLDERS AND CONTRIBUTORS "AS IS" AND ANY EXPRESS OR IMPLIED WARRANTIES, INCLUDING, BUT NOT LIMITED TO, THE IMPLIED WARRANTIES OF MERCHANTABILITY AND FITNESS FOR A PARTICULAR PURPOSE ARE DISCLAIMED. IN NO EVENT SHALL THE COPYRIGHT HOLDER OR CONTRIBUTORS BE LIABLE FOR ANY DIRECT, INDIRECT, INCIDENTAL, SPECIAL, EXEMPLARY, OR CONSEQUENTIAL DAMAGES (INCLUDING, BUT NOT LIMITED TO, PROCUREMENT OF SUBSTITUTE GOODS OR SERVICES; LOSS OF USE, DATA, OR PROFITS; OR BUSINESS INTERRUPTION) HOWEVER CAUSED AND ON ANY THEORY OF LIABILITY, WHETHER IN CONTRACT, STRICT LIABILITY, OR TORT (INCLUDING NEGLIGENCE OR OTHERWISE) ARISING IN ANY WAY OUT OF THE USE OF THIS SOFTWARE, EVEN IF ADVISED OF THE POSSIBILITY OF SUCH DAMAGE.

3.2 Apache License 2.0

Apache License Version 2.0, January 2004

<http://www.apache.org/licenses/>

TERMS AND CONDITIONS FOR USE, REPRODUCTION, AND DISTRIBUTION

1. Definitions.

"License" shall mean the terms and conditions for use, reproduction, and distribution as defined by Sections 1 through 9 of this document.

"Licensor" shall mean the copyright owner or entity authorized by the copyright owner that is granting the License.

"Legal Entity" shall mean the union of the acting entity and all other entities that control, are controlled by, or are under common control with that entity. For the purposes of this definition, "control" means

- (i) the power, direct or indirect, to cause the direction or management of such entity, whether by contract or otherwise, or
- (ii) ownership of fifty percent (50%) or more of the outstanding shares, or
- (iii) beneficial ownership of such entity.

"You" (or "Your") shall mean an individual or Legal Entity exercising permissions granted by this License.

"Source" form shall mean the preferred form for making modifications, including but not limited to software source code, documentation source, and configuration files.

"Object" form shall mean any form resulting from mechanical transformation or translation of a Source form, including but not limited to compiled object code, generated documentation, and conversions to other media types.

"Work" shall mean the work of authorship, whether in Source or Object form, made available under the License, as indicated by a copyright notice that is included in or attached to the work (an example is provided in the Appendix below).

"Derivative Works" shall mean any work, whether in Source or Object form, that is based on (or derived from) the Work and for which the editorial revisions, annotations, elaborations, or other modifications represent, as a whole, an original work of authorship.

For the purposes of this License, Derivative Works shall not include works that remain separable from, or merely link (or bind by name) to the interfaces of, the Work and Derivative Works thereof.

"Contribution" shall mean any work of authorship, including the original version of the Work and any modifications or additions to that Work or Derivative Works thereof, that is intentionally submitted to Licensor for inclusion in the Work by the copyright owner or by an individual or Legal Entity authorized to submit on behalf of the copyright owner. For the purposes of this definition, "submitted" means any form of electronic, verbal, or written communication sent to the Licensor or its representatives, including but not limited to communication on electronic mailing lists, source code control systems, and issue tracking systems that are managed by, or on behalf of, the Licensor for the purpose of discussing and improving the Work, but excluding communication that is conspicuously marked or otherwise designated in writing by the copyright owner as "Not a Contribution."

"Contributor" shall mean Licensor and any individual or Legal Entity on behalf of whom a Contribution has been received by Licensor and subsequently incorporated within the Work.

2. Grant of Copyright License.

Subject to the terms and conditions of this License, each Contributor hereby grants to You a perpetual, worldwide, non-exclusive, no-charge, royalty-free, irrevocable copyright license to reproduce, prepare Derivative Works of, publicly display, publicly perform, sublicense, and distribute the Work and such Derivative Works in Source or Object form.

3. Grant of Patent License

Subject to the terms and conditions of this License, each Contributor hereby grants to You a perpetual, worldwide, non-exclusive, no-charge, royalty-free, irrevocable (except as stated in this section) patent license to make, have made, use, offer to sell, sell, import, and otherwise transfer the Work, where such license applies only to those patent claims licensable by such Contributor that are necessarily infringed by their Contribution(s) alone or by combination of their Contribution(s) with the Work to which such Contribution(s) was submitted. If You institute patent litigation against any entity (including a cross-claim or counterclaim in a lawsuit) alleging that the Work or a Contribution incorporated within the Work constitutes direct or contributory

patent infringement, then any patent licenses granted to You under this License for that Work shall terminate as of the date such litigation is filed.

4. Redistribution.

You may reproduce and distribute copies of the Work or Derivative Works thereof in any medium, with or without modifications, and in Source or Object form, provided that You meet the following conditions:

1. You must give any other recipients of the Work or Derivative Works a copy of this License;
and
2. You must cause any modified files to carry prominent notices stating that You changed the files;
and
3. You must retain, in the Source form of any Derivative Works that You distribute, all copyright, patent, trademark, and attribution notices from the Source form of the Work, excluding those notices that do not pertain to any part of the Derivative Works;
and
4. If the Work includes a "NOTICE" text file as part of its distribution, then any Derivative Works that You distribute must include a readable copy of the attribution notices contained within such NOTICE file, excluding those notices that do not pertain to any part of the Derivative Works, in at least one of the following places: within a NOTICE text file distributed as part of the Derivative Works; within the Source form or documentation, if provided along with the Derivative Works; or, within a display generated by the Derivative Works, if and wherever such third-party notices normally appear. The contents of the NOTICE file are for informational purposes only and do not modify the License. You may add Your own attribution notices within Derivative Works that You distribute, alongside or as an addendum to the NOTICE text from the Work, provided that such additional attribution notices cannot be construed as modifying the License.

You may add Your own copyright statement to Your modifications and may provide additional or different license terms and conditions for use, reproduction, or distribution of Your modifications, or for any such Derivative Works as a whole, provided Your use, reproduction, and distribution of the Work otherwise complies with the conditions stated in this License.

5. Submission of Contributions

Unless You explicitly state otherwise, any Contribution intentionally submitted for inclusion in the Work by You to the Licensor shall be under the terms and conditions of this License, without any additional terms or conditions. Notwithstanding the above, nothing herein shall supersede or modify the terms of any separate license agreement you may have executed with Licensor regarding such Contributions.

6. Trademark

This License does not grant permission to use the trade names, trademarks, service marks, or product names of the Licensor, except as required for reasonable and customary use in describing the origin of the Work and reproducing the content of the NOTICE file.

7. Disclaimer of Warranty

Unless required by applicable law or agreed to in writing, Licensor provides the Work (and each Contributor provides its Contributions) on an "AS IS" BASIS, WITHOUT WARRANTIES OR CONDITIONS OF ANY KIND, either express or implied, including, without limitation, any warranties or conditions of TITLE, NON-INFRINGEMENT, MERCHANTABILITY, or FITNESS FOR A PARTICULAR PURPOSE. You are solely responsible for determining the appropriateness of using or redistributing the Work and assume any risks associated with Your exercise of permissions under this License.

8. Limitation of Liability

In no event and under no legal theory, whether in tort (including negligence), contract, or otherwise, unless required by applicable law (such as deliberate and grossly negligent acts) or agreed to in writing, shall any Contributor be liable to You for damages, including any direct, indirect, special, incidental, or consequential damages of any character arising as a result of this License or out of the use or inability to use the Work (including but not limited to damages for loss of goodwill, work stoppage, computer failure or malfunction, or any and all other commercial damages or losses), even if such Contributor has been advised of the possibility of such damages.

9. Accepting Warranty or Additional Liability

While redistributing the Work or Derivative Works thereof, You may choose to offer, and charge a fee for, acceptance of support, warranty, indemnity, or other liability obligations and/or rights consistent with this License. However, in accepting such obligations, You may act only on Your own behalf and on Your sole responsibility, not on behalf of any other Contributor, and only if You agree to indemnify, defend, and hold each Contributor harmless for any liability incurred by, or claims asserted against, such Contributor by reason of your accepting any such warranty or additional liability.

END OF TERMS AND CONDITIONS

APPENDIX: How to apply the Apache License to your work.

To apply the Apache License to your work, attach the following boilerplate notice, with the fields enclosed by brackets "[]" replaced with your own identifying information. (Don't include the brackets!) The text should be enclosed in the appropriate comment syntax for the file format. We also recommend that a file or class name and description of purpose be included on the same "printed page" as the copyright notice for easier identification within third-party archives.

Copyright [yyyy] [name of copyright owner]

Licensed under the Apache License, Version 2.0 (the "License");
you may not use this file except in compliance with the License.

You may obtain a copy of the License at
<http://www.apache.org/licenses/LICENSE-2.0>

Unless required by applicable law or agreed to in writing, software distributed under the License is distributed on an "AS IS" BASIS, WITHOUT WARRANTIES OR CONDITIONS OF ANY KIND, either express or implied.

See the License for the specific language governing permissions and limitations under the License.

Bosch Thermotechnik GmbH
Junkersstrasse 20-24
D-73249 Wernau

www.bosch-thermotechnology.com